

APP1504-1CP

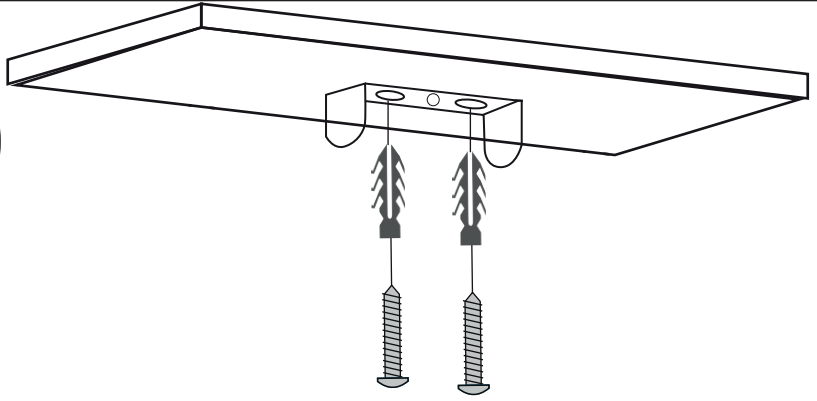

1

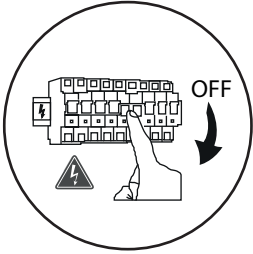
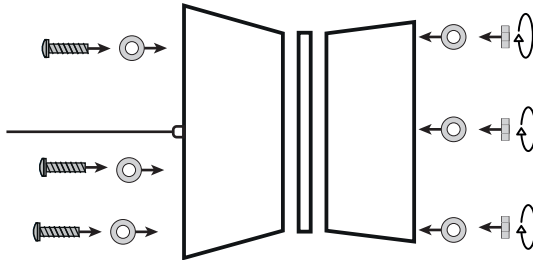

2



3

